











TORTUGA OUTDOOR > Rio Vista 6Pc Sofa Set ~ ASSEMBLY MANUAL

SOFA

Parts List:

No.	Part	Qty	Image	No.	Part	Qty	Image
A1	Left Arm	1		A2	Right Arm	1	
B	chair back	1		C	Seat Panel	1	
D	Washer	12		E	Screw(φ6x15mm)	8	
F	Screw(φ6x35mm)	4		G	Allen Wrench	1	
H	Seat Cushion	3		I	Back Cushion	3	

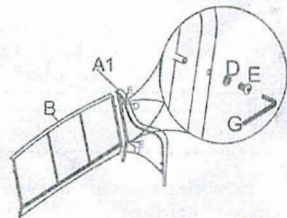

Step 1: Secure sofa back (B) to left arm (A1) with 2 washer (D) and 2 screws (E) by using allen wrench (G). Do not fully tighten now.

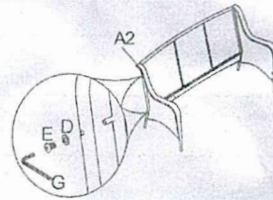

Step 2: Secure right arm (A2) to assembled sofa back (B) with 2 washer (D) and 2 screws (E) by using allen wrench (G). Do not fully tighten now.

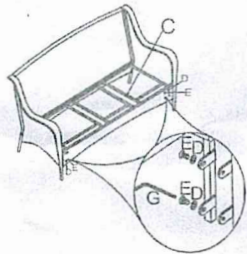

Step 3: Secure seat panel (C) to assembled sofa arms (A1.A2) with 4 washer (D) and 4 screws (E) by using allen wrench (G). Do not fully tighten now.

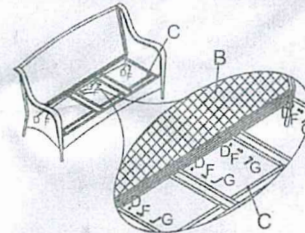

Step 4: Secure seat panel (C) to assembled sofa back (B) with 4 washer (D) and 4 screws (F) by using allen wrench (G), verify the alignment and adjust, fully tighten all the screws now.

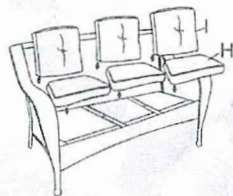

Step 5 & 6: Put seat cushion (H) and back cushion (I) on the sofa. The sofa is assembled.

TORTUGA OUTDOOR > Rio Vista 6Pc Sofa Set ~ ASSEMBLY MANUAL

6PCS RESIN WICKER SET WITH CUSHIONS SOFA & COFFEE TABLE

ASSEMBLY INSTRUCTION

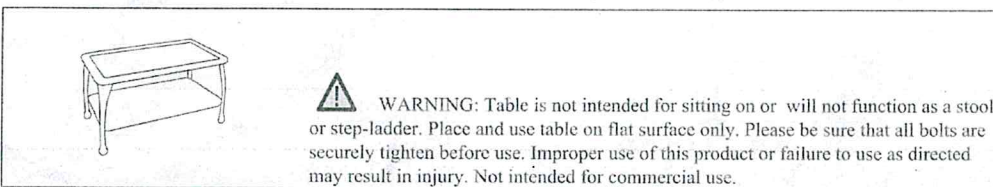
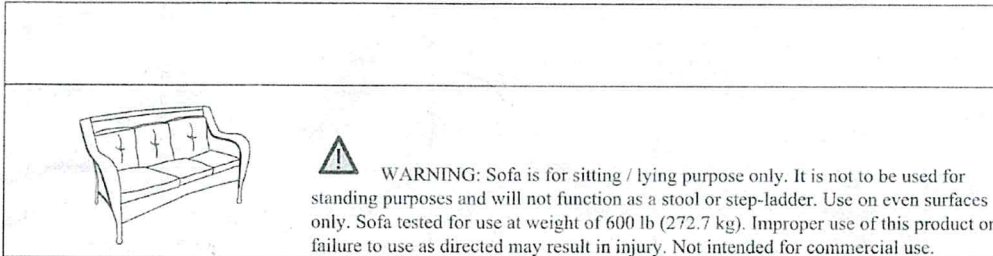

IMPORTANT:

Please read all the instructions and warnings before assembling. In order to make the whole product adjust to the best, please install all the screws on the product and tighten all the screws after adjusting the product which can stand on the floor even.

WARNING:

- Keep all children and pets away from assembly area. Children and pets should be supervised when they are in the area of the product construction.
- Keep assembly area at least 6 feet from any obstruction such as a fence, garage, house, overhanging branches, laundry line or electrical wires.
- Some parts may contain sharp edges. When assembling and using this product, basic safety precautions should always be followed to reduce the risk of personal injury and damage to the product. Please read all instructions before assembly and use.
- Check all bolts for tightness before use. **IMPORTANT** - check and tighten bolts often to keep them secure!
- The sofa and coffee table are not to be used for standing purposes and will not function as a stool or step-ladder. Use on even surfaces only.
- The sofa use at weight of 600lb (272.7kg). Improper use of this product or failure to use as directed may result in injury. Not intended for commercial use.

CARE & MAINTENANCE

STAIN RESISTANT CUSHIONS CARE — KEEP THE CUSHIONS IN STORAGE IN RAINING DAY.

SPILLS: Immediately wipe up the spill using a white damp cloth. Repeat process if necessary until stain is gone. Allow cushion to air dry.

FABRIC CARE: Hand wash cold, non-chlorine bleach when needed, lay flat to dry. Cool iron if necessary. Do not dry clean.

RESIN WICKER PRODUCT CARE

Before using, clean the product completely with a soft dry towel. When not in use, wipe free of any dirt or loose objects, wash with a mild solution of soap and water, rinse thoroughly and dry completely. Do not use strong detergent or abrasive cleaners. Over time nuts and bolts can loosen. Occasionally, check nuts and bolts on all chairs and tables, re-tighten if necessary.

TORTUGA OUTDOOR > Rio Vista 6Pc Sofa Set ~ ASSEMBLY MANUAL

6PC SEDONA RESIN CHAT SET

CHAIRS & OTTOMANS

ASSEMBLY INSTRUCTION



WARNING: Proper use of the chair is for single person seating only. The chair is not to be used for standing purposes and will not function as a stool or step-ladder. Use on even surfaces only. Chair tested for use at weight of 250 lb (113.4 kg). Improper use of this product or failure to use as directed may result in injury. Not intended for commercial use.



WARNING: Proper use of the ottoman is for single person to rest legs on while sitting in chair. The ottoman is not to be used for seating or standing purposes and will not function as a stool or step-ladder. Ottoman will support up to weight of 250 lb (113.4 kg). Improper use of this product or failure to use as directed may result in injury. Not intended for commercial use.

IMPORTANT:

Please read all the instructions and warnings before assembling. In order to make the whole product adjust to the best, please install all the screws on the product and tighten all the screws after adjusting the product which can stand on the floor even.

WARNING:

- Keep all children and pets away from assembly area. Children and pets should be supervised when they are in the area of the product construction.
- Keep assembly area at least 6 feet from any obstruction such as a fence, garage, house, overhanging branches, laundry line or electrical wires.
- Some parts may contain sharp edges. When assembling and using this product, basic safety precautions should always be followed to reduce the risk of personal injury and damage to the product. Please read all instructions before assembly and use.
- Check all bolts for tightness before use. IMPORTANT - check and tighten bolts often to keep them secure!
- The chairs and ottomans are not to be used for standing purposes and will not function as a stool or step-ladder. Use on even surfaces only.
- The chair use at wight of 250lb (113.4kg). Improper use of this product or failure to use as directed may result in injury. Not intended for commercial use.

CARE & MAINTENANCE

STAIN RESISTANT CUSHIONS CARE — KEEP THE CUSHIONS IN STORAGE IN RAINING DAY.

SPILLS: Immediately wipe up the spill using a white damp cloth. Repeat process if necessary until stain is gone. Allow cushion to air dry.

FABRIC CARE: Hand wash cold, non-chlorine bleach when needed, lay flat to dry. Cool iron if necessary. Do not dry clean.











RESIN WICKER PRODUCT CARE

Before using, clean the product completely with a soft dry towel. When not in use, wipe free of any dirt or loose objects, wash with a mild solution of soap and water, rinse thoroughly and dry completely. Do not use strong detergent or abrasive cleaners. Over time nuts and bolts can loosen. Occasionally, check nuts and bolts on all chairs and tables, re-tighten if necessary.

TORTUGA OUTDOOR > Rio Vista 6Pc Sofa Set ~ ASSEMBLY MANUAL

CHAIR

Parts List:

No.	Part	Qty	Image	No.	Part	Qty	Image
A1	Left Arm	1		A2	Right Arm	1	
B	chair back	1		C	Seat Panel	1	
D	Washer	10		E	Screw(φ6x15mm)	8	
F	Screw(φ6x35mm)	2		G	Allen Wrench	1	
H	Seat Cushion	1		I	Back Cushion	1	

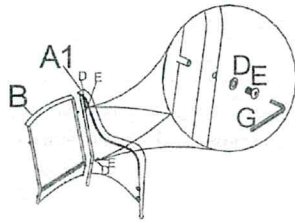

Step 1: Secure chair back (B) to left arm (A1) with 2 washer (D) and 2 screws (E) by using allen wrench (G). Do not fully tighten now.

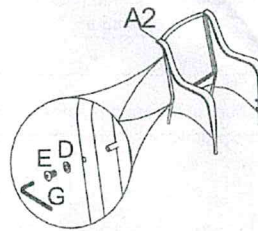

Step 2: Secure right arm (A2) to the other side of assembled chair back (B) with 2 washer (D) and 2 screws (E) by using allen wrench (G).

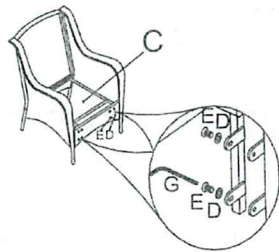

Step 3: Secure seat panel (C) to assembled sofa arms (A1.A2) with 4 washer (D) and 4 screws (E) by using allen wrench (G). Do not fully tighten now.

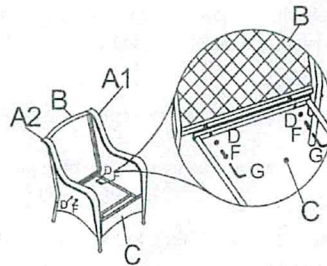

Step 4: Secure seat panel (C) to assembled sofa back (B) with 2 washer (D) and 2 screws (F) by using allen wrench (G), verify the alignment and adjust, fully tighten all the screws now.

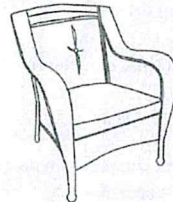







Step 5 & 6: Put seat cushion (H) and back cushion (I) on the chair. The chair is assembled.

TORTUGA OUTDOOR > Rio Vista 6Pc Sofa Set ~ ASSEMBLY MANUAL

OTTOMAN

Parts List:

No.	Part	Qty	Image
A	Left /Right Leg	2	
B	Seat Panel	1	
C	Cushion	1	
D	Washer	8	
E	Screw(φ6x15mm)	8	
G	Allen Wrench	1	

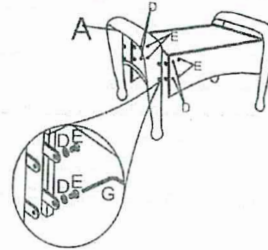
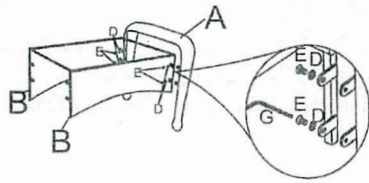

Step 1: Secure right leg (A) with washer (D) and screws (E) by using allen wrench (G). Do not fully tighten now.

Step 2: Secure left leg (A) with washer (D) and screws (E) by using allen wrench (G).

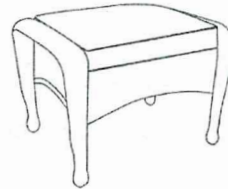

Step 3 & 4: Put seat cushion (C) on the panel. The ottoman is assembled.



WARNING: DO NOT SEAT ON THE OTTOMAN.

Stained-Wood-Look Rectangle Aluminum LPG Fire Pit

Item#: 63964

***ELECTRONIC IGNITER!**
Requires AAA Battery (not included)

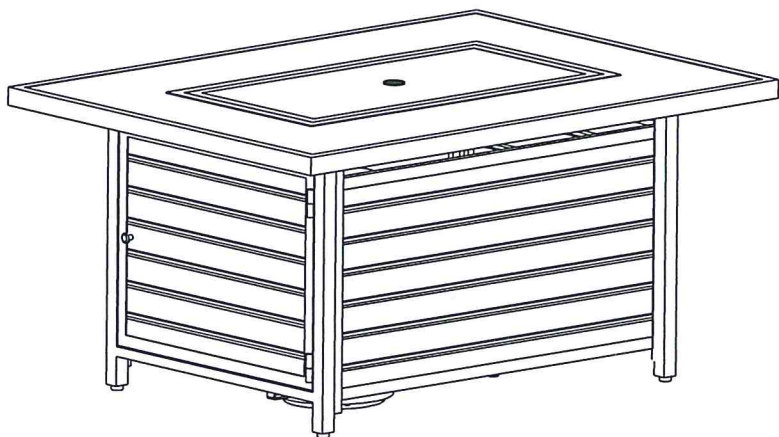

Installation Precaution

This fire pit requires a minimum 18 inches of cross-ventilation in all directions.
Failure to provide proper ventilation can void the warranty.



ATTACH YOUR RECEIPT HERE

Keep a copy of your proof of purchase or order confirmation which will be needed if you need to contact us about warranty coverage.

Purchase Date: _____

Conforms to ANSI STD Z21.97-2017,
Certified to CSA STD 2.41-2017 Outdoor decorative gas appliances

WARNING FOR YOUR SAFETY

1. Improper installation, adjustment, alteration, service or maintenance can cause injury or property damage.
2. Read the installation, operation, and maintenance instructions thoroughly before installing or servicing this equipment.
3. Failure to follow these instructions could result in fire or explosion, which could cause property damage, personal injury, or death.

WARNING

For Outdoor Use Only

WARNING

This product can expose you to chemicals including Carbon Monoxide, Lead, Chromium (hexavalent compounds), Di(2-ethylhexyl) phthalate (DEHP) and Diisononyl phthalate (DINP), which are known to the State of California to cause cancer and birth defects or other reproductive harm. For more information, go to www.P65Warnings.ca.gov.



TABLE OF CONTENTS

Before You Begin	Page 2
Package Contents	Page 3
Safety Information	Page 4
Assembly	Pages 5-7
Operating Instructions	Pages 8-11
Conversion to Natural Gas	Pages 12-14
Care and Maintenance	Page 15
Troubleshooting	Page 16
Warranty Information	Page 17



BEFORE YOU BEGIN

Please read and understand this entire manual before attempting to assemble, operate or install this appliance. If you have any questions regarding the product, please contact your retailer.

This manual contains important information about the assembly, operation and maintenance of this LPG fire pit. General safety information is presented in the first few pages and is also located throughout this manual. Keep this manual for future reference and to educate new users of this appliance.

PACKAGE CONTENTS

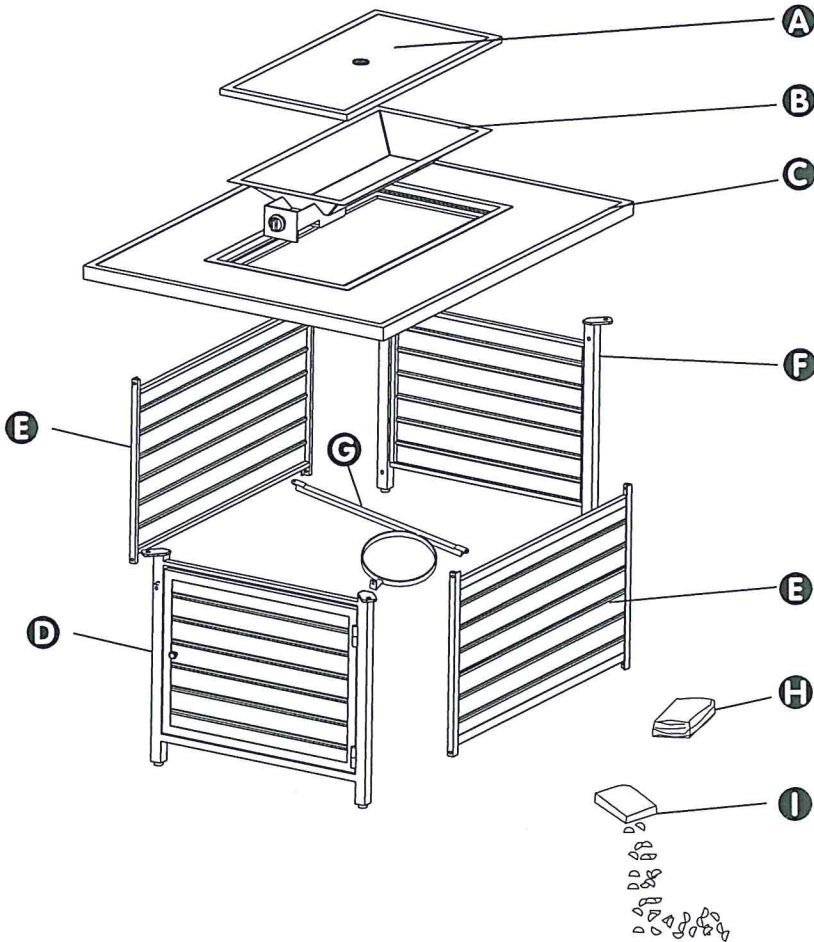

PART	DESCRIPTION	QUANTITY
A	Removable Burner Cover	1
B	Burner	1
C	Table Top	1
D	Front Door Panel	1
E	Side Panels	2
F	Back Panel	1
G	Gas Tank Support	1
H	Protective Cover	1
I	Fire Glass	1

Also required but not included:
AAA Battery (install by unscrewing igniter button)



HARDWARE CONTENTS

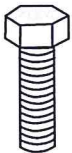

L

Bolt 8x20mm

Qty: 5

(4 for assembly +1 extra)

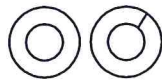

M

Washer, Spring Washer 8mm

Qty: 5

(4 for assembly +1 extra)



N

Bolt 6x25mm

Qty: 9

(8 for assembly +1 extra)



O

Bolt 6x18mm

Qty: 4

(3 for assembly +1 extra)



P

Washer 6mm

Qty: 12

(11 for assembly +1 extra)



Q

Plastic Cap (M8)

Qty: 4



TOOLS

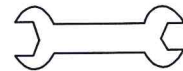

R

Wrench



S

Hex Key

SAFETY INFORMATION

SAFETY INFORMATION

This appliance has been tested to and complies with the ANSI Z21.97-2017, Outdoor Decorative Gas Appliances CGA CR 97-003 Outdoor Gas Fireplaces. The installation must conform to local codes or in the absence of local codes to the National Fuel Gas Code, ANSI Z223.1. This manual contains important information about the assembly, operation and maintenance of this fire pit. General safety information is presented in these first few pages and is also located throughout the manual. Keep this manual for future reference and to educate new users of this product. This manual should be read in conjunction with the labeling on the product. Safety precautions are essential when any mechanical or propane fueled equipment is involved. These precautions are necessary when using, storing, and servicing. Using the equipment with the respect and caution demanded will reduce the possibilities of personal injury or property damage. The following symbols (shown below) are used extensively throughout this manual. Always heed these precautions, as they are essential when using any mechanical or propane fueled equipment.

WARNING

Failure to comply with the precautions and instructions provided with this fire pit can result in death, serious bodily injury and property loss or damage from hazards of fire, explosion, burn, asphyxiation, and/or carbon monoxide poisoning. Only persons who can understand and follow the instructions should use or service this fire pit.

WARNING / DANGER

WARNING/DANGER indicates an imminently hazardous situation which, if not avoided, will result in death or serious injury.

WARNING

Do not store or use gasoline or other flammable vapors and liquids in the vicinity of this or any other appliance. An LP-cylinder not connected for use shall not be stored in the vicinity of this or any other appliance.

WARNING

Solid fuels shall not be burned in this appliance.

DANGER

EXPLOSION—FIRE HAZARD

- Keep solid combustibles, such as building materials, paper, or cardboard a safe distance away from the fire pit as recommended by the instructions.
- Provide adequate clearances around air openings into the combustion chamber. Never use the fire pit in spaces which do or may contain volatile or airborne combustibles, or products such as gasoline, solvents, paint thinner, dust particles, or unknown chemicals.
- During operation, this appliance can be a source of ignition. Keep fire pit area clear and free from combustible materials, gasoline, paint thinner, cleaning solvents and other flammable vapors and liquids. Do not use fire pit in areas with high dust content. Minimum fire pit clearances from combustible materials: 2 feet (24 inches) from the sides & 2 feet (24 inches) from the rear, 6 feet (72 inches) from ceiling.
- Never store propane near high heat, open flames, pilot lights, direct sunlight, other ignition sources or where temperatures exceed 120 degrees F (49 degrees C).
- Propane vapors are heavier than air and can accumulate in low places. If you smell gas, leave the area immediately.
- Never install or remove a propane cylinder while the fire pit is lighted, or near flame, pilot lights, or other ignition sources or while fire pit is hot to the touch.
- This fire pit is red hot during use and can ignite flammables too close to the burner. Keep flammables at least 6 feet (72 inches) from top and 2 feet (24 inches) from sides. Keep gasoline and other flammable liquids and vapors well away from fire pit.
- Store the propane cylinder outdoors in a well ventilated space out of the reach of children. Never store the propane cylinder in an enclosed area (house, garage, etc.). If fire pit is to be stored indoors, disconnect the propane cylinder for outdoor storage.

WARNING

- This fire pit is fueled by propane gas. Propane gas is invisible, odorless, and flammable. An odorant is normally added to help detect leaks and can be described as having a "rotten egg" smell. The odorant can fade over time so leaking gas is not always detectable by smell alone.
- Propane gas is heavier than air and leaking propane will sink to the lowest level possible. It can ignite by ignition sources including matches, lighters, sparks, or open flames of any kind many feet away from the original leak. Use only propane gas set up for vapor withdrawal.
- Store or use propane gas in compliance with local ordinances and codes or with ANSI/NFPA 58. Turn off propane when not in use.

DANGER

FOR YOUR SAFETY

If you smell gas:

1. Shut off gas to the appliance.
2. Extinguish any open flame
3. If odor continues, keep away from the appliance and immediately call your gas supplier or fire department.

WARNING

We cannot foresee every use which may be made of our fire pit. Check with your local fire safety authority if you have questions about fire pit use. Other standards govern the use of fuel gases and heat producing products for specific uses. Your local authorities can advise you about these. If no local codes exist, follow National Fuel Gas Code, ANSI Z223.1. In Canada, installation must conform to local codes. If no local codes exist, follow the current National standards of CANADA CAN/CGA-B 149.2.

WARNING: FOR OUTDOOR USE ONLY CARBON MONOXIDE HAZARD

- This fire pit is a combustion appliance. All combustion appliances produce carbon monoxide (CO) during the combustion process. This product is designed to produce extremely minute, non-hazardous amounts of CO if used and maintained in accordance with all warnings and instructions. Do not block air flow into or out of the fire pit.
- Carbon Monoxide (CO) poisoning produces flu-like symptoms, watery eyes, headaches, dizziness, fatigue and possibly death. You can't see it and you can't smell it. It's an invisible killer. If these symptoms are present during operation of this product get fresh air immediately!
- For outdoor use only. Using this fire pit in an enclosed space can kill you. Never use this fire pit in an enclosed space such as a camper, tent, home, or other unventilated or enclosed area.
- This fire pit consumes air (oxygen). Do not use in unventilated or enclosed areas to avoid endangering your life.



WARNING

Improper installation, adjustment, alteration, service or maintenance can cause property damage, injury or death. Read the installation, operation and maintenance instructions thoroughly before installing or servicing this equipment.

ASSEMBLY



PREPARATION

Before beginning assembly, be sure to empty contents of carton and make sure all parts are present. If any parts are missing, please contact the retailer.

Place all parts on a soft, level surface for assembly. NOTE: it is recommended to use TWO PEOPLE to assemble this gas fire pit. Estimated assembly time: 60 minutes. | Do NOT overtighten hardware!

1 Locate 4 Panels **D/E/F**. NOTE: There is a hole at the bottom of each Side Panel **E**. The hole should face DOWN.

Place a Washer **P** on each of 8 Bolts **N** and insert through holes in sides of Side Panels into the holes in sides of Leg Panels **D/F**.

Tighten all Bolts **N** with Hex Key **S**.

Hardware: **N** Bolt (6x25mm) x 8
P Washer (6mm) x 8

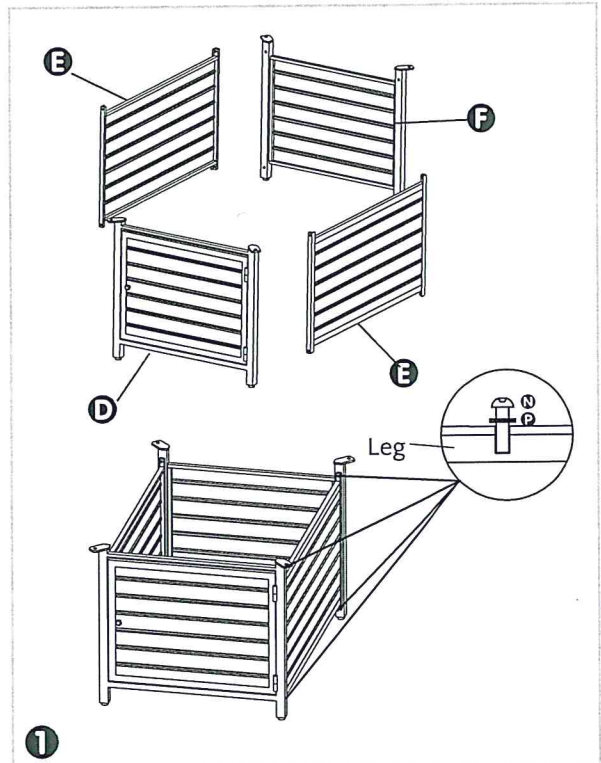

2 Once all Panels are bolted together, carefully turn the table base upside-down. Attach Gas Tank Support **G** to Side Panels **E** by aligning holes in Gas Tank Support with holes in the bottom of Side Panels and Door.

Place a Washer **P** on each of 2 Bolts **G** and insert into aligned holes. Tighten with Hex Key **S**.

Hardware: **G** Bolt (6x18mm) x 2
P Washer (6mm) x 2

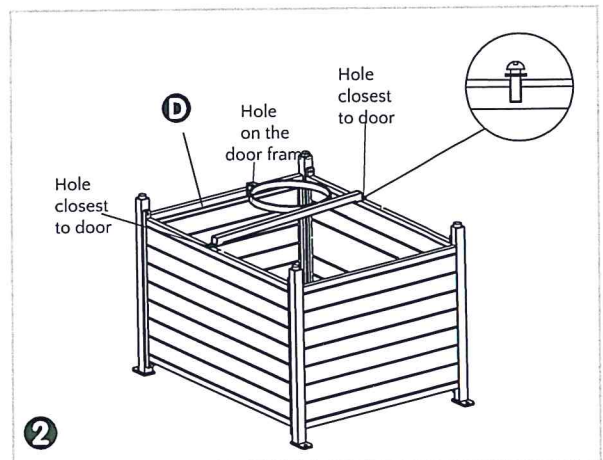

ASSEMBLY

3 Turn the assembled table base upright, then place **Table Top** **C** over **Legs**, and align the holes on **Table Top** with holes at the top of **Legs**. Place **Spring Washer** **M**, then **Washer** **N** on each of 4 **Bolts** **L**, then insert into the aligned holes. Tighten with **Wrench** **R**, then cover bolt heads with **Plastic Caps** **O**.

Hardware:

- L Bolt** (8x20mm) x 4
- M Washer/Spring Washer** (8mm) x 4t
- O Plastic Cap** x 4

WARNING:

This fire pit is constructed of aluminum, a relatively soft, flexible metal. Do not sit, stand, or lean heavily on the top of the fire pit, which can cause bending or warping.

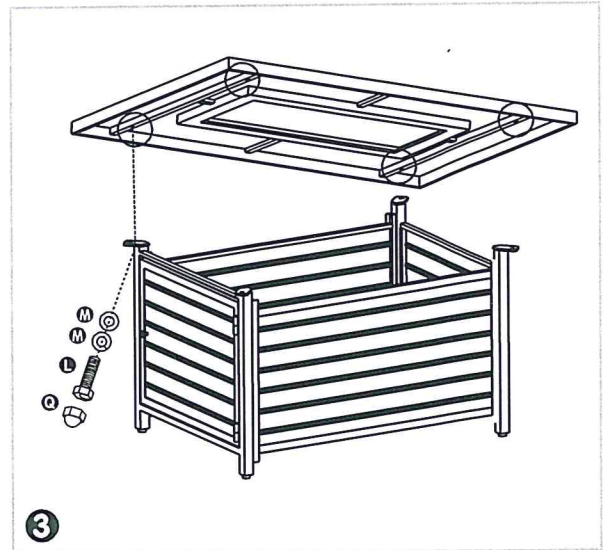

4 Place the **Burner** **B** into the hole in the **Table Top** **C**. Make sure the **Control Knob** on the **Burner** faces the **Front Door Panel** **D**.

Unscrew the igniter button and insert a AAA Battery with positive end facing out. Screw the button back onto the control panel.



ASSEMBLY

- 5** Pour the **Fire Glass ①** around the **Burner**. Be careful not to obstruct pilot light housing. Put the **Removable Burner Cover ②** on the **Burner**.

When the fire pit is NOT in use, or after use, when the fire pit has cooled COMPLETELY, cover it with the **Protective Cover ③**. DO NOT PUT THE PROTECTIVE FIRE PIT COVER ON A HOT FIRE PIT.

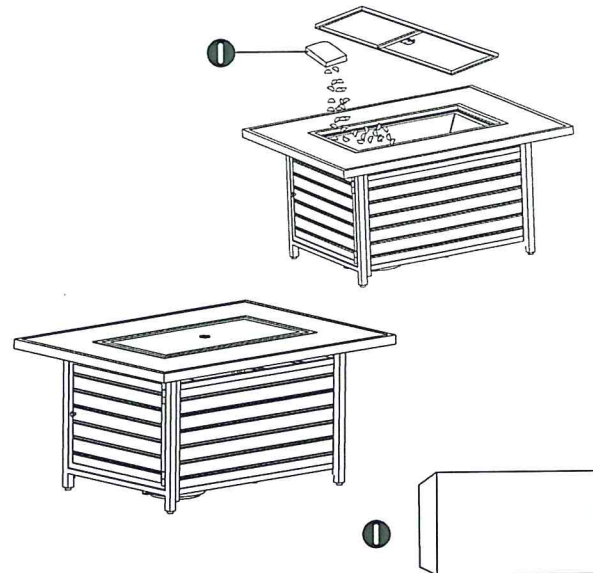

- 6** Connect hose and regulator to cylinder. The propane gas and cylinder are sold separately. Use a standard 20lb propane cylinder only. Use this fire pit only with a propane vapor withdrawal supply system. See chapter 5 of the standard storage and handling of liquefied petroleum gas, ANSI/NFPA 58. Your local library or fire department should have this book.

Storage of an appliance indoors is permissible only if the cylinder is disconnected and removed from the appliance. A cylinder must be stored outdoors in a well-ventilated area out of the reach of children. A disconnected cylinder must have dust caps tightly installed and must not be stored in a building, garage or any other enclosed area. The maximum inlet gas supply pressure: 250 PSI, the minimum inlet gas supply pressure: 5 PSI.

for automatic operation at ratings less than full input rating. The pressure regulator and hose assembly supplied with the appliance must be used.

The installation must conform with local codes, or in the absence of local codes, with national fuel gas code, ANSI Z223.1/NFPA54, natural gas and propane Installation Code, CSA B 149.1, or propane storage and handling code, B149.2.

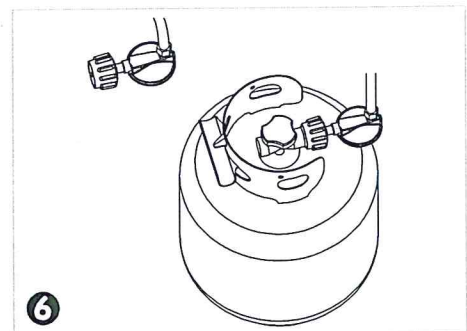
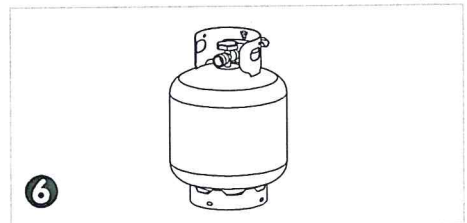

OPERATING INSTRUCTIONS

A dented, rusted or damaged propane cylinder may be hazardous and should be checked by your cylinder supplier. Never use a propane cylinder with a damaged valve connection.

The propane cylinder must be constructed and marked in accordance with the specifications for LP gas cylinders of the U.S. Department of Transportation (DOT) or the standard for cylinders, spheres and tubes for transportation of dangerous goods and commission, CAN/CSA-B339.

The cylinder must have a listed overfilling prevention device.

The cylinder used must include a collar to protect the cylinder valve.

Never connect an unregulated propane cylinder to the fire pit.

Attach regulator to cylinder. Complete attachment. Install cylinder.

- Do not store a spare LP gas cylinder under or near this appliance;
- Never fill the cylinder beyond 80 percent full;
- Place the dust cap on the cylinder valve outlet whenever the cylinder is not in use. Only install the type of dust cap on the cylinder valve that is provided with the cylinder valve. Other type of caps or plugs may result in leakage of propane.

ATTENTION: THIS PRODUCT IS NOT FOR COMMERCIAL USE. IT IS INTENDED FOR RESIDENTIAL USE ONLY.

- Do not sit or stand on this table.
- Keep children away during assembly. This item contains small parts which can be swallowed by children.
- Do not use indoors or inside any enclosure.
- Retain the assembly instructions for future reference.
- Installer – please leave these instructions with the owner.

OPERATING INSTRUCTIONS

LEAK CHECK

⚠ WARNING!

- Perform all leak tests outdoors.
- Extinguish all open flames.
- NEVER leak test when smoking.
- Do not use the fire pit until all connections have been leak tested and do not leak.

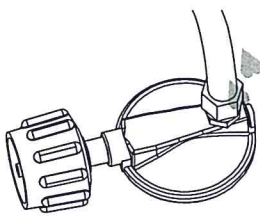

Hose / Regulator
Connection

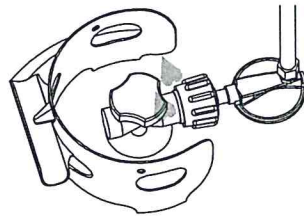

Regulator / Cylinder
Connection

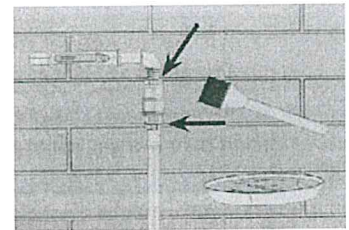
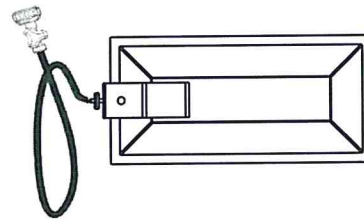

1. Make 2-3 oz. of leak test solution (one part liquid dishwashing detergent and three parts water).
2. Apply several drops of solution where hose attaches to regulator.
3. Apply several drops of solution where regulator connects to cylinder.
4. Make sure all valves are turned OFF.
5. Turn cylinder valve ON.

If bubbles appear at any connection there is a leak.

1. Turn cylinder valve OFF.
2. If leak is at hose/regulator connection: tighten connection and perform another leak test. If bubbles continue appearing, the hose should be returned to the place of purchase.
3. If leak is at regulatory/cylinder valve connection: disconnect, reconnect, and perform another leak test. If you continue to see bubbles after several attempts, cylinder valve is defective and should be returned to cylinder's place of purchase.

If NO bubbles appear at any connection, the connections are secure.

NOTE: Whenever gas connections are loosened or removed, you must perform a complete leak test. Complete installation.

OPERATING INSTRUCTIONS

CAUTION

Do not attempt to operate until you have read and understand all General Safety Information in this manual, all assembly is complete, and leak test has been performed.

DANGER!

FOR OUTDOOR USE ONLY

CARBON MONOXIDE HAZARD

Never use this inside a house or other unventilated or enclosed areas. This fire pit consumes air (oxygen). Do not use in unventilated or enclosed areas to avoid endangering your life.

WARNING

Very hot while in operation!

Never lean over the fire pit while in use. Do not touch Table Top or burner Assembly while the fire pit is in operation. Fire pit will be hot after use. Handle with care. Wait until fire pit has cooled down after use before placing lid on Table Top or touching any surfaces. Failure to follow these instructions may result in serious bodily injury.

WARNING

FOR YOUR SAFETY

Be careful when attempting to manually ignite this fire pit. Holding in the control knob for more than 10 seconds before igniting the gas will cause a ball of flame upon ignition.



OPERATION CHECKLIST:

For a safe and pleasant heating experience, review this checklist before each use:

- I am familiar with entire owner's manual and understand all precautions noted.
- All components are properly assembled, intact, and operable.
- No alterations have been made.
- All gas connections are secure and do not leak.
- Wind velocity is below 10mph.
- I understand the unit will operate at reduced efficiency below 40°F.
- I understand the fire pit is for outdoor use (outside any enclosure).
- There is adequate fresh air ventilation.
- Fire pit is away from gasoline and other flammable liquids or vapors.
- Fire pit is away from windows, air intake openings, sprinklers, and other water sources.
- Fire pit is at least two (2) feet on all sides/front/back and six (6) feet overhead from combustible materials.
- Fire pit is on a hard and level surface.
- There are no signs of spider/insect nests in fire pit orifices.
- All burner passages and air circulation passages are clear.
- I understand children and adults should be alerted to the hazard of high surface temperatures and should stay away to avoid burns or clothing ignition.
- I understand young children should be carefully supervised when they are in the area of the fire pit.
- I understand clothing or other fabric material should not be hung from the fire pit or placed on or near the fire pit.
- I understand that any guard or other protective device removed for servicing the fire pit must be replaced prior to operating the fire pit.
- I understand installation and repair should be done by a qualified service person, and that the fire pit should be inspected before each use and at least annually by a qualified service person.
- I understand that more frequent cleaning may be required as necessary and that it is imperative that the control compartment, burner, and circulating air passageways of the fire pit be kept clean.
- The fire pit is constructed of aluminum, a relatively soft/flexible metal, and I should not allow anyone to sit or lean heavily on the top of the fire pit, which can cause bending or warping.



BEFORE TURNING GAS SUPPLY ON:

1. Your fire pit was designed and approved for outdoor use only. Do NOT use it inside a building, garage, or any other enclosed area.
2. Make sure surrounding areas are free of combustible materials, gasoline, and other flammable vapors or liquids.
3. Ensure that there is no obstruction to air ventilation. Be sure all gas connections are tight and there are no leaks.
4. Be sure the cylinder is clear of debris. Be sure any component removed during assembly or servicing is replaced and fastened prior to starting.

OPERATING INSTRUCTIONS

NOTE: This model has an Electronic Igniter and requires one AAA battery. Unscrew IGNITER BUTTON to install.



Electronic igniter requires AAA battery

⚠ DANGER!
FOR OUTDOOR USE ONLY

⚠ CARBON MONOXIDE HAZARD

Never use this fire pit inside a house or other unventilated or enclosed areas. This fire pit consumes air (oxygen). Do not use in unventilated or enclosed areas to avoid endangering your life.

WHEN FIRE PIT IS ON:

Burner will display tongues of blue and yellow flame. These flames should not produce thick black smoke, indicating an obstruction of airflow through the burners. If excessive flame is detected, turn off fire pit and consult the **Troubleshooting** section of this manual.

BEFORE LIGHTING:

1. Smell all around the unit area for gas. Be sure to smell near the floor, because gas is heavier than air and will settle to the lowest point. If you smell gas, shut off the gas to the appliance, extinguish any open flame, and if odor persists, call your gas supplier or the fire department.
2. Fire pit should be thoroughly inspected before each use, and by a qualified service person at least annually. If relighting a hot fire pit, always wait at least 5 minutes.
3. Inspect hose assembly for evidence of excessive abrasion, cuts, or wear. Suspect areas should be leak tested. If the hose leaks, it must be replaced prior to operation. Only use the replacement hose assembly specified by manufacturer.

LIGHTING:

NOTE: Use only your hand to depress or turn the gas control knob. Never use tools. If the knob will not depress or turn by hand, DO NOT try to repair it. Call a qualified professional service technician. Force or attempted repair may result in fire or explosion and will void the warranty.

1. Turn the control knob to "OFF" position (Fig. A).
2. Fully open LP cylinder valve. **Note: For initial start or after any cylinder change, hold Control Knob IN for 2 minutes to purge air from gas lines before proceeding.**
3. Push in and turn the control knob counterclockwise to HIGH (Fig. B).
4. While holding control knob in, push the Electronic Ignition button to ignite the main burner. (The ignition will produce a soft snapping/crackling sound. If the fire pit does not light and there is no snapping sound, replace the battery.)
5. After fire pit lights, wait 45 seconds, then release control knob.
6. Observe the flame height when lit. Flame should reach between 3 and 13 inches in height. Overly short or tall flame can indicate a problem.
7. To decrease the flame, turn the control knob clockwise to LOW (Fig. C). To increase the flame, turn the control knob counterclockwise to HIGH (Fig. B).

NOTE: If burner fails to remain lit, close all valves and wait at least 5 minutes before attempting to light.

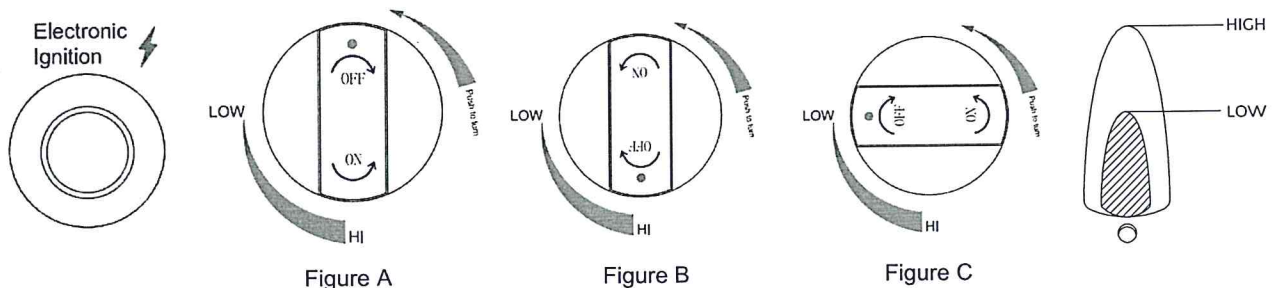

SHUT DOWN:

1. To extinguish burner depress control knob and turn it clockwise to OFF.
2. Turn cylinder valve clockwise to OFF and disconnect regulator when fire pit is not in use.

AFTER-OPERATION CHECKLIST:

1. Gas control knob is in OFF position.
2. Gas tank valve is OFF.
3. Gas line is disconnected.

CONVERSION TO NATURAL GAS

WARNING

Make sure all control knobs and cylinder valves are in OFF position before converting.

This appliance is portable and configured for use with Liquid Propane (LP Gas), which is delivered via removable tanks (LP tanks and their use are covered elsewhere in this manual). If a Natural Gas connection is available, the user may wish to change the gas delivery system to the more permanent Natural Gas Supply.

This appliance is certified for use with either Liquid Propane (LP Gas) or Natural Gas and comes complete with the necessary parts to convert the appliance for use with Natural Gas. A Natural Gas hose and regulator are also required and are sold separately. The conversion valves allow the use of Natural Gas without replacing the burners or entire valve system.

The process of converting the burner from Propane to Natural Gas is relatively simple and can be accomplished by any handy homeowner. We recommend, however, that a qualified gas technician do the conversion. Your warranty may be voided if the conversion is improperly completed. Please retain the parts supplied with the appliance and these instructions so the technician can do the conversion.

Orifice Chart

The different burner valves in this appliance have different BTU ratings. The holes in the orifices are drilled to different sizes so as to allow the proper amount of gas to flow through them. Please note the chart below to give an easy reference for the various orifice opening sizes for the different valves in the appliance.

Propane (Pressure 11")		NG (Pressure 7")	
Orifice Size	Input Rate (BTU/h)	Orifice Size	Input Rate (BTU/h)
2.3mm	55,000	3.78mm	55,000

NG Hose and Regulator Conversion

Tools Required:

- Adjustable Wrench (2)

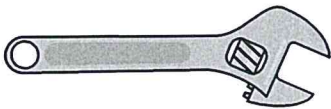

WARNING

Make sure all appliance components are completely cooled and gas supply is turned off and removed from the appliance prior to performing the conversion.

CONVERSION TO NATURAL GAS

⚠️ WARNING! To avoid the possibility of burns conversion should only be done when the patio flame. Ensure burner is turned off. Turn gas off at source and disconnect the appliance before beginning conversion.

⚠️ WARNING! Fire Glass may have sharp edges. Wear safety glasses and gloves when handling.

⚠️ WARNING! We recommend that the conversion be performed by a licensed gas fitter, and all connections must be leak tested prior to operating the appliance.

Your fire pit can be easily converted for Natural Gas by following these steps:

1. If desired, remove the Burner from the enclosure. (Remove the Fire Glass from the Burner first.) Take care not to damage or kink the **Thermocouple Wire**. Alternatively, you may wish to perform the conversion from below via the **Tank Access Door**.
2. Disconnect the stainless steel **Flex Line** from the brass **Connector Valve** using two Wrenches.
3. Unscrew the **Connector Valve** from the **Burner Pipe**.
4. Slide the **Air Shutter** tube included in the conversion kit onto the **Burner Pipe**, covering the vent screens.
5. Remove the small brass **Propane Orifice** from the burner end of the **Connector Valve**.
6. Replace the **Propane Orifice** with the **Natural Gas Orifice** supplied. Fully tighten with Wrench for a secure seal.
7. Screw the **Connector Valve** back into the **Burner Pipe**. Fully tighten with Wrench for a secure seal.
8. Re-attach **Flex Line** to **Connector Valve**. Fully tighten with Wrenches for a secure seal.
9. Place **Burner** back into enclosure if you removed it.
10. Place the **Conversion Label** included with your **Conversion Kit** on the inside of the **Tank Access Door**.
11. Replace the existing LPG hose and regulator with an NG regulator and hose (not included).
12. **Connect your gas supply and perform a Leak Test at each connection point.** Leak Test instructions are found elsewhere in this manual.

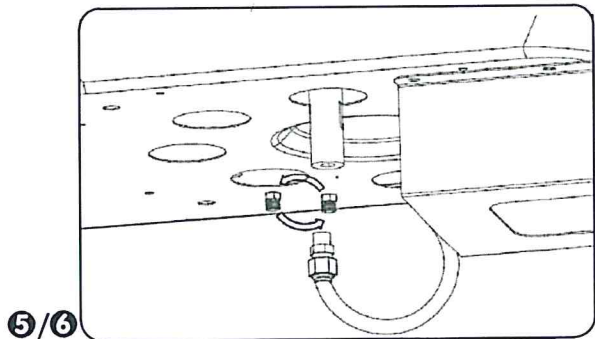
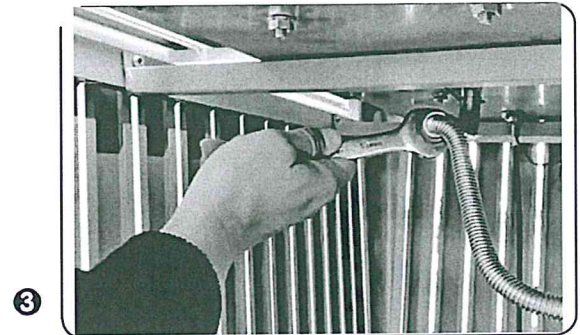
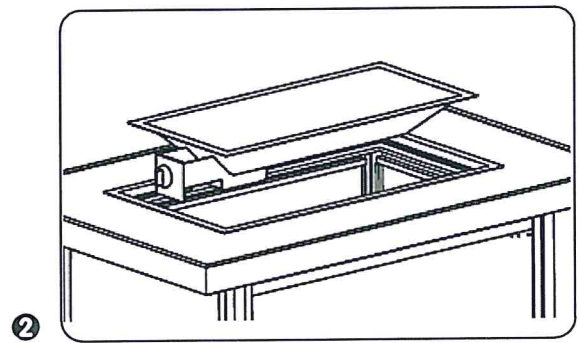

CONVERSION TO NATURAL GAS

Natural Gas Hook-Up

The gas appliance is designed to operate at an inlet pressure of 7 inches water column. The piping up to the appliance is the responsibility of the installer. Connect the inlet valve to rigid pipe, copper tube or an approved flexible metal connector, which complies with Z21.4/CSA 6.10. If using a gas hose (not supplied) connect the flared end of the hose to the connector on the end of the inlet valve. Tighten using two wrenches. (Do not use thread sealer/pipe dope.) Leak test all joints prior to using the appliance. Piping and valves upstream of the quick disconnect are not supplied. The gas supply pipe must be sufficiently sized to supply the BTU/h specified on the rating plate, based on the length of the piping run. The quick disconnect must not be installed in an upward direction and a readily accessible manual shut-off valve must be installed upstream of, and as close to, the quick disconnect as is feasible.

Purge the gas supply line of any trapped air prior to the first firing of the unit.

WARNING!

- The installation must be performed by a licensed gas fitter, and all connection must be leak tested before operating the appliance.
- Ensure all hose connections are tightened using two wrenches. Do not use Teflon tape or pipe dope on any hose connection.
- Ensure the hose does not contact any high temperature surfaces or it may melt and leak causing a fire.
- Locate the hose away from pathways where people may trip over it and areas where the hose may be subject to accidental damage.
- Leak test all the connections using a soap and water solution as per the leak testing instructions found in the manual.

CARE & MAINTENANCE

To enjoy years of outstanding performance from your fire pit, make sure you perform the following maintenance activities on a regular basis:

1. Use warm soapy water for cleaning. Never use flammable or corrosive cleaning agents.
2. While cleaning your unit, be sure to keep the area around the burner and control compartment dry at all times. Do not submerge the control valve assembly. If the gas control is submerged in water, do NOT use it. It must be replaced. Make sure fire pit has cooled completely before cleaning or covering with a cover.
 - A. Keep the appliance area clear and free from combustible materials, gasoline and other flammable vapors and liquids.
 - B. Do not obstruct the flow of combustion and ventilation air.
 - C. Keep the ventilation opening(s) of the cylinder enclosure free and clear from debris.
3. Air flow must be unobstructed. Keep controls, burner, and circulating air passageways clean. Signs of possible blockage include:
 - Gas odor with extreme yellow tipping of flame.
 - Fire pit does NOT reach the desired temperature.
 - Fire pit glow is excessively uneven.
 - Fire pit makes popping noise.
 - Spiders and insects can nest in burner or orifices. This dangerous condition can damage fire pit and render it unsafe for use. Clean burner holes by using a heavy-duty pipe cleaner. Compressed air may help clear away smaller particles.
 - Carbon deposits may create a fire hazard. Clean burner screen with warm soapy water if any carbon deposits develop.



Note: In a salt-air environment (such as near an ocean), corrosion occurs more quickly than normal. Frequently check for corroded areas and repair them promptly.

SERVICE:

Only a qualified service person should repair gas passages and associated components.

WARNING

FOR YOUR SAFETY

- Do NOT touch or move fire pit for at least 45 minutes after use.
- Burner is hot to the touch.
- Allow burner to cool before touching.

STORAGE:

Between uses:

- Turn control knob OFF.
- Disconnect LP source.
- Store fire pit in an area sheltered from direct contact with inclement weather (such as rain, sleet, hail, snow, dust and debris).
- If desired, cover fire pit to protect exterior surfaces and to help prevent build-up in air passages.

During periods of extended inactivity or when transporting:

- Turn control knob OFF.
- Disconnect LP source and move to a secure, well-ventilated location outdoors.
- Store fire pit in an area sheltered from direct contact with inclement weather (such as rain, sleet, hail, snow dust and debris).
- If desired, cover fire pit to protect exterior surfaces and to help prevent build-up in air passages. Never leave LP cylinder exposed to direct sunlight or excessive heat.

Note: Wait until fire pit is cool before covering.

Caution: Always allow fire pit to cool before attempting service.

TROUBLESHOOTING

PROBLEM	POSSIBLE CAUSE	CORRECTIVE ACTION
Burner will not light	Propane cylinder is frosted over	Wait until the propane cylinder warms up and becomes unfrosted
	Blockage in orifice	Clear blockage
	Control knob is not in ON position	Turn control knob to ON
Burner flame is low	Gas pressure is low	Turn cylinder valve OFF and replace cylinder
	Outdoor temperature is less than 40°F and tank is less than 1/4 full	Use a full cylinder
	Control knob fully ON	Check burner and orifices for blockage
Carbon build-up Thick Black Smoke	Dirt or film on burner screen	Clean burner screen
	Blockage in burner	Remove blockage and clean burner screen inside and outside.



1 YEAR LIMITED WARRANTY – Customers in the Contiguous US

All components are warranted for a period of 1 year after date of purchase by the original owner against defects in materials and workmanship under normal use. This warranty does NOT cover normal wear and weathering, assembly and/or maintenance OR use in a commercial application if model is not designated as a commercial model. At the manufacturer's sole discretion, products under warranty will be repaired and/or replaced at no charge to the customer. Any returns sent back to the manufacturer must be sent via prepaid freight and in the original retail packaging.

This warranty is extended only to the original purchaser. Proof of purchase will be required before warranty service is rendered. The sales receipt is the only valid proof of purchase. This warranty only covers failures due to defects in materials or workmanship which occur during normal use. Failures and/or damage which result from accident, negligence, misuse, abuse, neglect, mishandling, alteration or modification, failure to maintain, improper assembly or maintenance, service by unauthorized agency or use of unauthorized components or damage that is attributable to acts of God are NOT covered.

*****THERE ARE NO EXPRESS WARRANTIES EXCEPT AS LISTED ABOVE*****

*****PURCHASER ASSUMES ALL RISKS IN THE ASSEMBLY AND OPERATION OF THIS UNIT*****

*****FAILURE TO FOLLOW WARNINGS AND OPERATIONAL INSTRUCTIONS CONTAINED IN THIS MANUAL CAN RESULT IN SEVERE PROPERTY DAMAGE AND/OR PERSONAL INJURY*****

IN NO EVENT WILL THE MANUFACTURER, OR ITS DIRECTORS, OFFICERS OR AGENTS BE LIABLE TO THE PURCHASER OR ANY THIRD PARTY, WHETHER IN CONTRACT, IN TORT, OR ON ANY OTHER BASIS, FOR ANY INDIRECT, SPECIAL, PUNITIVE, EXEMPLARY, CONSEQUENTIAL, OR INCIDENTAL LOSS, COST, OR DAMAGE ARISING OUT OF OR IN CONNECTION WITH THE SALE, MAINTENANCE, USE, OR INABILITY TO USE THE PRODUCT, EVEN IF THE MANUFACTURER OR ITS DIRECTORS, OFFICERS OR AGENTS HAVE BEEN ADVISED OF THE POSSIBILITY OF SUCH LOSSES, COSTS OR DAMAGES, OR IF SUCH LOSSES, COSTS, OR DAMAGES ARE FORESEEABLE. IN NO EVENT WILL THE MANUFACTURER, OR ITS OFFICERS, DIRECTORS, OR AGENTS BE LIABLE FOR ANY DIRECT LOSSES, COSTS OR DAMAGES THAT EXCEED THE PURCHASE PRICE OF THE PRODUCT.

SOME JURISDICTIONS DO NOT ALLOW THE EXCLUSION OR LIMITATION OF INCIDENTAL OR CONSEQUENTIAL DAMAGES, SO THE ABOVE LIMITATION OR EXCLUSION MAY NOT APPLY TO THE PURCHASER.

This limited warranty gives you specific legal rights and you may also have other rights which vary from jurisdiction to jurisdiction. The provisions of the United Nations Convention on Contracts for the Sales of Goods shall not apply to this limited warranty or the sale of products covered by this limited warranty.